



THUNDERFORM®



**F150C04BK12A-TN / F150C04C12A-TN
FORD F-150 SUPER CREW
VEHICLE SPECIFIC SUBWOOFER ENCLOSURE
OWNER'S MANUAL**



THANK YOU

Thank you for making the AWESOME decision to purchase our MTX Audio vehicle specific subwoofer enclosure designed for the Ford F-150 Super Crew. Our sub enclosure, with its 12" Terminator subwoofer, will belt out the bass and deliver ground pounding audio making you the party vehicle! With a few basic hand tools in your trusty toolbox, you can have this installed in no time. So, what are you waiting for? It's time to get the rumble in your ride! Oh, and congratulations on your purchase, thanks for your support and most importantly, enjoy the ultimate audio experience with MTX!

WE'RE HERE TO HELP

We're here to help with any installation or technical support. Visit mtx.com to chat, call 1-800-225-5689 to speak with an MTX Technical Support representative, or visit youtube.com/user/MTXAudioUSA to view product videos.

DON'T FORGET TO REGISTER YOUR PRODUCT

Don't forget to register your new MTX Audio product. Visit mtx.com/productregistration or scan the QR code to the right.

Model # _____

Serial # _____

Dealer's Name _____

Date of Purchase _____



IMPORTANT NOTICE

Whenever working on the vehicle, it is recommended to disconnect the battery prior to starting work. Failure to do so may lead to a risk of electric shock or equipment damage.

When connecting power and ground wires ensure that the red power wire is fused at the point where it is connected to the vehicle's battery. Failure to do so can result in damage to the vehicle if a short circuit develops between the vehicle connection point and the product.



FEATURES

- Includes One MTX 12" Terminator Subwoofer
- Integrated Amplifier Easily Connects to Existing Systems
- Rotationally Molded Design, Finished in Black or Charcoal
- Mounts Under Rear Seat Driver Side
- EBC and Wiring Harness Included

SPECIFICATIONS

- Single 12" Amplified Subwoofer Enclosure
- RMS Power Handling: 200-Watts
- Peak Power Handling: 400-Watts
- Signal-to-Noise Ratio (1 Watt): > 75dB
- Frequency Response: 10Hz - 78Hz
- Impedance: 4Ω

FIT GUIDE

Super Crew	2004 - 2008
Super Cab.....	2004 - 2008

REQUIRED TOOLS

- Powered Screwdriver
- #2 Phillips Head Bit
- Wire Cutters
- 5/16" Wrench
- 10mm Wrench
- Terminal Crimper

IN THE BOX

- F150C04BK12A-TN or F150C04C12A-TN Amplified Subwoofer Enclosure
- EBC
- Wiring Harness

INSTALLATION

Step 1 - Place enclosure under seat with woofer firing down. Make sure enclosure is against the seat and bracket.



Step 2 - If externally amplified make speaker connections to the enclosure from the amplifier. Connect speaker wires from amplifier to enclosure, positive to red terminal and negative to black terminal.

Amplified ThunderForm

Note: When routing power wire we recommend a connection directly to the battery.

Step 3 - Remove driver side threshold trim; pull up on trim. It will remove easily.

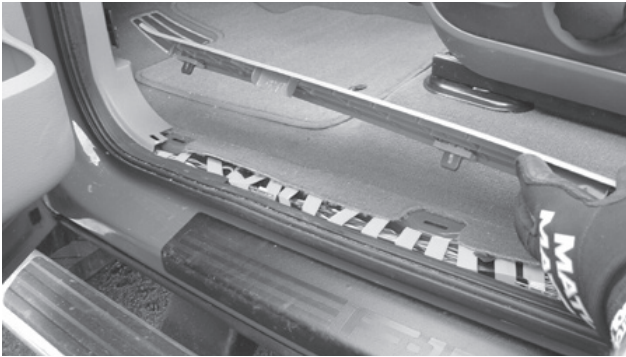

Step 4 - Remove rear driver door threshold trim. Pull up on trim; it will remove easily.



Step 5 - Using the furnished wiring harness route 10ga red power wire starting at pre-amp location. Route wire on driver side, over to threshold and under carpet to the front of vehicle.

Step 6 - Open hood.

Step 7 - Drill a hole through the firewall. Locate a spot low on the firewall on the driver side. You should always look to find a clear path. Drill a hole from inside of the vehicle into engine compartment and insert grommet. In this location you may also find a pre-existing rubber grommet to run the wire through. **Note:** To avoid any damage to parts inside engine compartment, drill from inside of vehicle using a short bit.

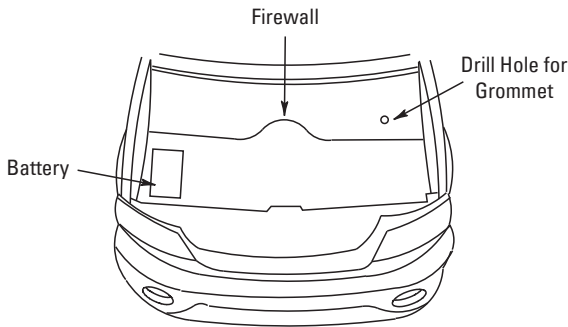

Step 8 - Route 10ga red power wire through grommet into the engine compartment.

Step 9 - Route 10ga red power wire through engine compartment safely away from any moving or hot parts that could damage the wire.

Step 10 - Cut 10ga red power wire to length, connect the supplied fuse holder from the wire kit to the end of the wire.

Step 11 - Remove 20 amp fuse from supplied fuse holder. Connect furnished ring terminal to positive side of battery. Remove 10mm bolt from factory battery terminal. Pass bolt through factory battery terminal, then ring terminal, and into the other side of factory battery terminal and retighten bolt.

Note: Always turn the ignition OFF when connecting or disconnecting battery cables. Failing to do so may damage electronic components.

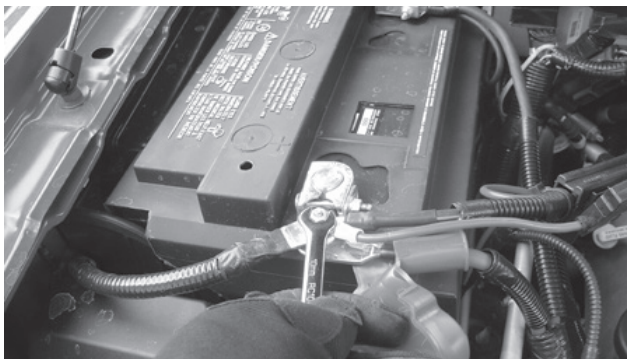

Step 12 - Ground amplifier to chassis of vehicle; connect the terminal provided to the 10ga black wire from furnished wiring harness. A good ground is as important as the power connection. The ground should be as short as possible and the contact point should be free of paint and debris.

Step 13 - Connect remote (Blue) wire to 12-volt switched accessory. To turn on the amplifier unit, a switched 12-volt signal is required. Locate a 12-volt wire that is active when the vehicle key is on and connect the blue remote wire to it. This may be found in the fuse panel, key-switch or radio harness.

Speaker Wires

Step 14 - You can find the factory speaker wires on the driver side of the truck under the threshold trim removed in Step 3. The wire colors for the left channel are; tan / yellow (positive) and gray / light blue (negative). The wire colors for the right channel are; orange / red (positive) and brown / pink (negative). Tap into wires and route over to passenger side threshold and to pre-amp of enclosure. Connect to the supplied High Level input harness wires and plug into the matching port on the pre-amp.

Although, MTX has made every effort to assure proper wiring colors, MTX is not responsible for any changes made by the vehicle manufacturer which sometime occur. If wiring colors do not match then physical verification is required.

Connection to Enclosure

Conventional Wiring of Factory Radio

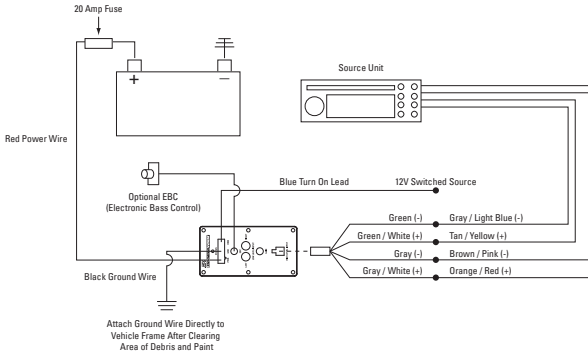

Conventional Wiring of Aftermarket Radio

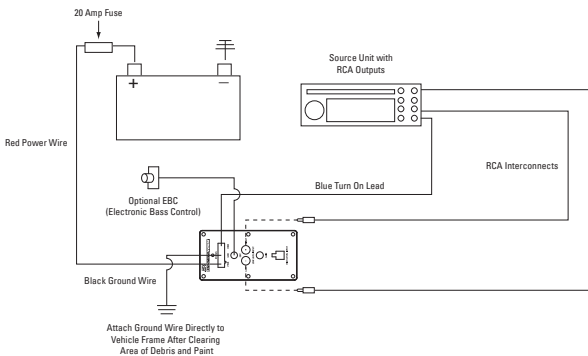

Step 15 - Plug power wire harness into amplifier pre-amp.

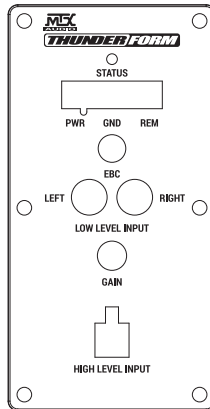

Step 16 - Replace 20 amp fuse under hood.

Step 17 - When amp turns on, LED will display red during diagnostic mode, and then green, signaling amp is on and functioning. Amp will only turn on when radio is on.

Step 18 - Adjust gain.

Setting Gain

Turn gain knob on ThunderForm pre-amp to minimum, counter clockwise. Play a favorite song that contains consistent music and bass. Turn the source unit to maximum listening level. You should know that some source units will produce distortion or “clip” before the unit reaches maximum volume. Reduce volume to the loudest listening level before distortion. Turn the gain knob on the ThunderForm pre-amp clockwise until the speaker starts to distort and reduce gain to loudest listening level before distortion.

Optional - The EBC, or Electronic Bass Control, allows a remote bass control to be adjusted from the driver’s seat.

Troubleshooting Tips if Amp Does Not Turn On

- Check all connections at battery and that fuse is installed
- Check speaker wire connections
- Check ground
- Check fuse on pre-amp

Step 19 - Reinstall threshold trim. Locate and align holes in vehicle with pins on trim; and snap back into place.



Step 20 - Screw enclosure to bracket (with rear driver door open you can screw enclosure to bracket easily). Make sure enclosure is tight against the bottom of the seat.



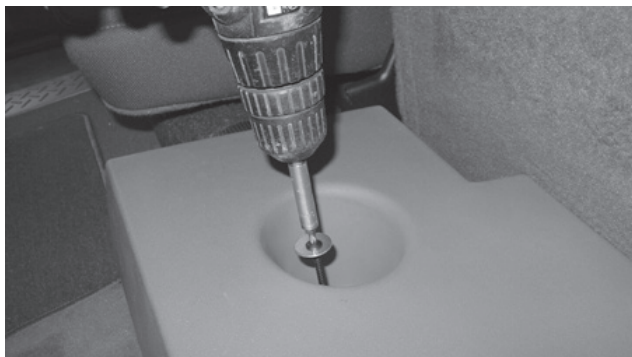

These instructions are guidelines only and in no way are intended to replace a professional installation. As always before screwing or drilling check to make sure you will not damage any wires or hoses or cause damage to the vehicle.

Warning: Batteries normally produce explosive gases which can cause personal injury. Therefore, do not allow flames, sparks or lighted substances to come near the battery. When charging or working near a battery, always shield your face and protect your eyes. Always provide ventilation.

WARRANTY PERIOD

At MTX Audio we engineer products that will stand up to the test of time. We also realize that from time to time a problem may occur. That's why our products carry a 2-year limited warranty that begins at the time of sale to the end user.

Of course, we're here to help. If you experience an issue with any of our products within the warranty period, please contact our customer service technical line at 1-800-CALL-MTX to help troubleshoot your issue. If, after speaking with our technical experts it is determined that a problem lies with the product, the technician will provide you with a Return Authorization number and all relevant details you'll need to get the product taken care of.

MITEK WARRANTY

MiTek Mobile products (including, but not limited to: MTX, Coustic, Streetwires, Xtant, BassSlammer, and Thunder Marine) purchased in the USA from an AUTHORIZED MITEK DEALER are guaranteed against defects in material and workmanship for the period of time specified. The warranty period begins the day the product is purchased by the end user, and this warranty is limited to the original retail purchaser of product. Products found to be defective during the warranty period will be repaired or replaced with equivalent product by MiTek at no charge. This warranty is void if it is determined that unauthorized parties have attempted repairs or alterations of any nature, and the warranty does not extend to cosmetics or finish. MiTek disclaims any liability for other incurred or consequential damages resulting from product defects. MiTek's total liability will not exceed the purchase price of the product.



Let's Get Social
mtx.com



Like, Follow, & Subscribe

© 2021 MiTek Corporation. All rights reserved. MTX is a trademark of MiTek Corporation. All other trademarks are property of their respective owners. Designed and Engineered in the U.S.A.

Due to continual product development, all specifications are subject to change without notice.

MTX Audio, 4545 East Baseline Rd. Phoenix, AZ 85042 U.S.A. 1-800-225-5689

MTX006399 RevA 2/21 • 1-10530